







Year 1 Knowledge Organiser

1	one	11	eleven
2	two	12	twelve
3	three	13	thirteen
4	four	14	fourteen
5	five	15	fifteen
6	six	16	sixteen
7	seven	17	seventeen
8	eight	18	eighteen
9	nine	19	nineteen
10	ten	20	twenty



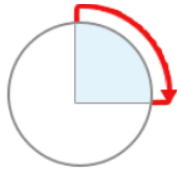
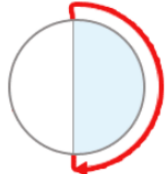

Months of the Year	
1 st	January
2 nd	February
3 rd	March
4 th	April
5 th	May
6 th	June
7 th	July
8 th	August
9 th	September
10 th	October
11 th	November
12 th	December

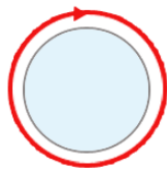

	add plus
	subtract minus
	equals







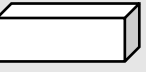



	
Clockwise	Anti-clockwise

 quarter turn	 half turn
 three-quarter turn	 full turn

Days of the Week
Monday
Tuesday
Wednesday
Thursday
Friday
Saturday
Sunday

2D Shapes	
 circle	 rectangle
 square	 triangle

3D Shapes	
 cube	 cuboid
 sphere	 pyramid

One pence	Two pence	Five pence	Ten pence	Twenty pence
				
1p	2p	5p	10p	20p
Fifty pence	One pound	Two pounds	Five pounds	Ten pounds
				
50p	£1	£2	£5	£10

